

PIATTAFORMA AUTOSOLLEVANTE MONOCOLONNA EP 3125/9
SINGLE MAST CLIMBING WORK PLATFORM EP 3125/9

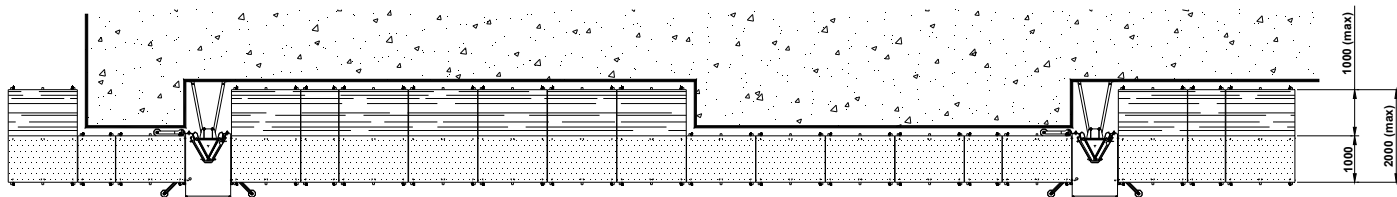
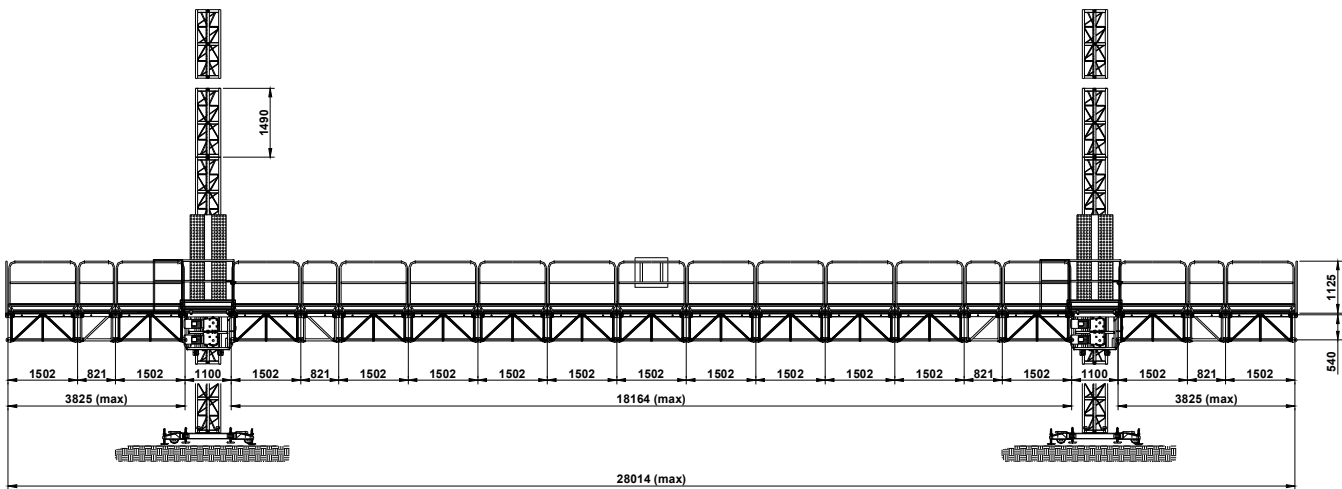

PIATTAFORMA AUTOSOLLEVANTE BICOLONNA EP 3125/28
TWIN MAST CLIMBING WORK PLATFORM EP 3125/28

Dati tecnici	Technical Data	Données Techniques	Datos Tecnicos	EP3125/9	EP3125/28
Massima capacità di carico	Max. capacity	Max charge	Max capacidad de carga	1650 kg	3500 kg
Velocità di sollevamento	Lifting speed	Vitesse de lévage	Velocidad de elevación	10,6 m/min	10,6 m/min
Max lunghezza piattaforma	Max platform length	Max longueur plate-forme	Longitud max plataforma	8,75 m	28 m
Larghezza piattaforma	Platform width	Largeur plate-forme	Ancho plataforma	1 m	1 m
Lunghezza Standard estensioni telesc.	Standard telesc. extension	Long. standard des extensions	Longitud standard extensiones	1 m	1 m
Max. Lunghezza estensioni telesc.	Max extension length	Max longueur extensions	Longitud max extensiones	2,5 m* max	2,5 m* max
Massima altezza libera	Max freestanding height	Hauteur max sans ancrages	Altura max autoestable	6 m	6 m
Massima altezza ancorata	Max anchored height	Hauter max avec ancrages	Altura max con anclajes	120 m	120 m
Intervallo ancoraggi	Max tie distance	Intervalle ancrages	Distancia entre anclajes	6 m max	6 m max
Tensione alimentazione	Input power range	Tension d'alimentation	Tensión de red	380/415 V 50/60 Hz	380/415 V 50/60 Hz
Potenza servizio continuo	Power of the motors	Puissance des moteurs	Potencia de motorreductores	2 x 2,2 kW	4 x 2,2 kW
Minima potenza di linea consigliata	Minimum line power suggested	Min. puissance de ligne conseillée	Min. potencia de linea	6 kW	10 kW

* Contattare Electroelsa

* Contact Electroelsa

DIMENSIONI BASE BASE FRAME DIMENSION

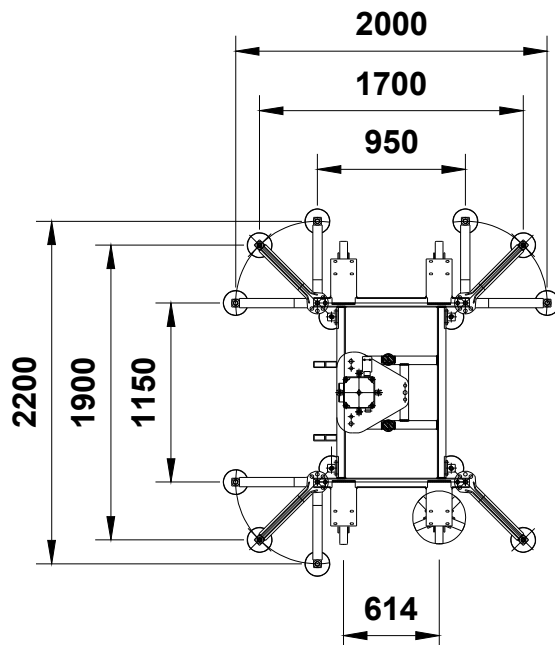

PESO PROPRIO MACCHINA SU CIASCUN BASAMENTO DEAD LOAD ON EACH BASE FRAME

H	EP 3125/9	EP 3125/28
12 m	2100 kg	2440 kg
24 m	2400 kg	2780 kg
36 m	2780 kg	3110 kg
48 m	3110 kg	3450 kg
60 m	3450 kg	3790 kg
72 m	3790 kg	4120 kg

N.B. Ai pesi sopra elencati aggiungere il 50% del carico trasportato
Add the 50% of the transported load to the above mentioned weights

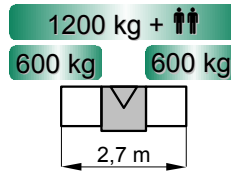

2 people = 240 kg
4 people = 400 kg

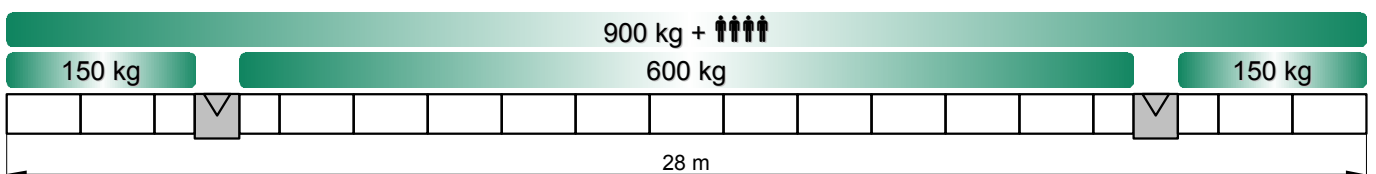
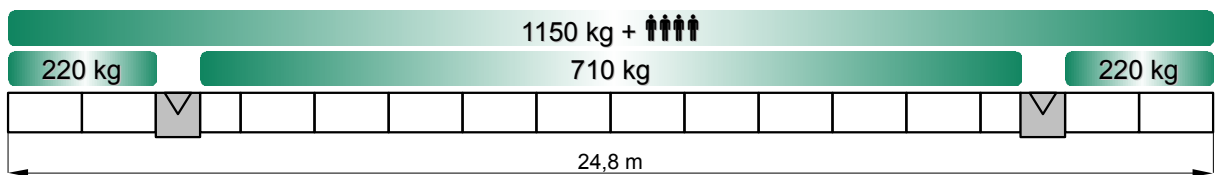
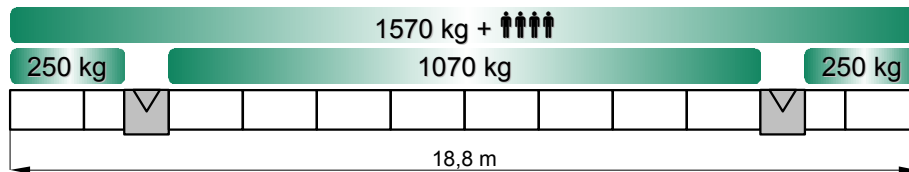
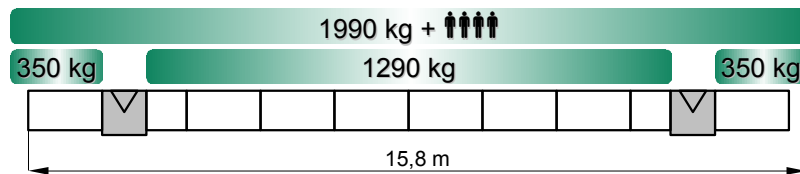
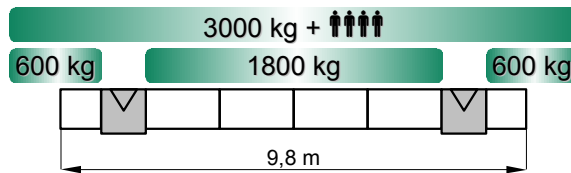
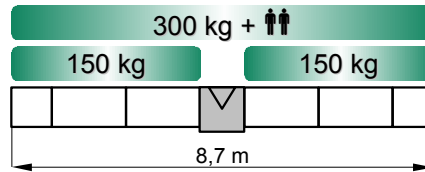
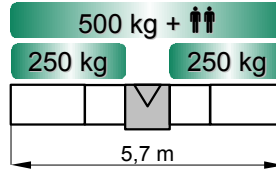

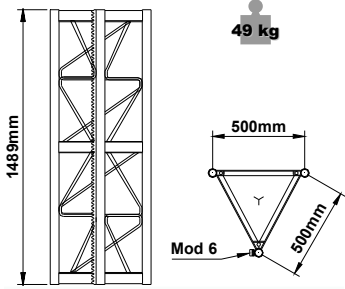

Dettagli colonna verticale
Mast section details

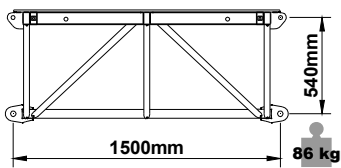

Dettagli modulo ponte
Deck module details

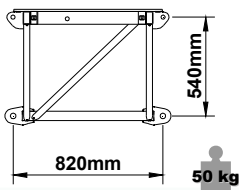

Dettagli modulo ponte
Deck module details

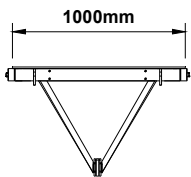

Vista frontale modulo ponte
Deck Module Front View

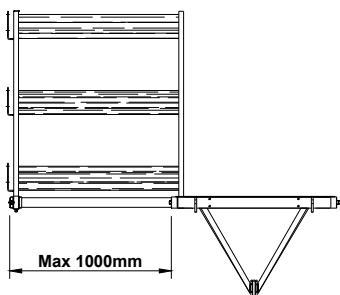

Estensioni a parete
Telescopic Wall Extensions

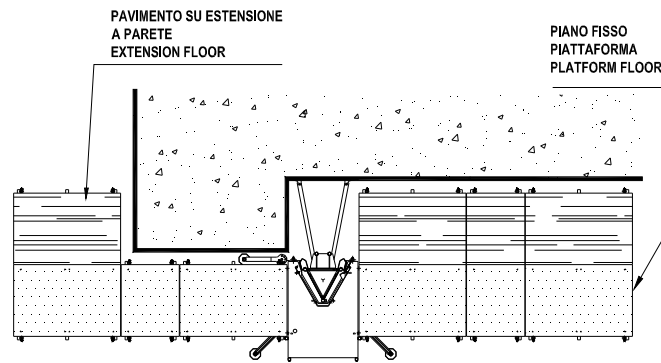
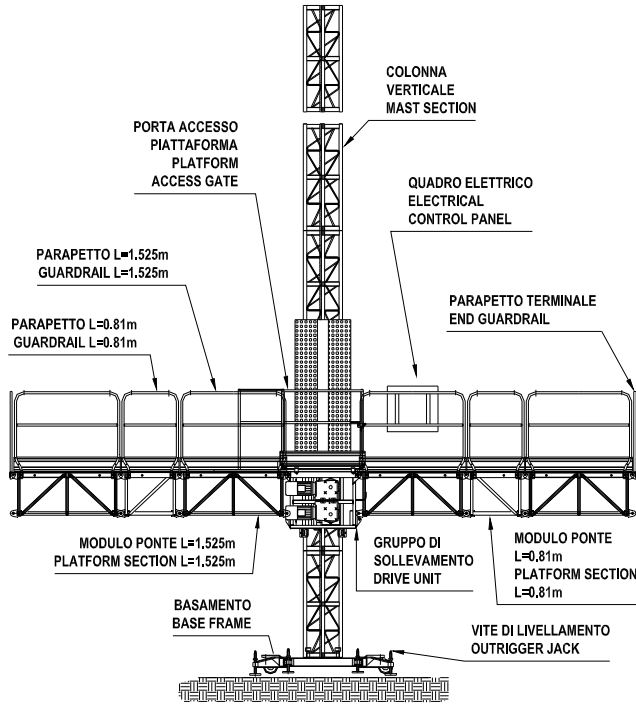

PAVIMENTO SU ESTENSIONE A PARETE
EXTENSION FLOOR

PIANO FISSO PIATTAFORMA
PLATFORM FLOOR

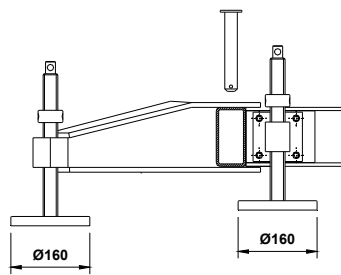

Stabilizzatori rimovibili
Removable outriggers

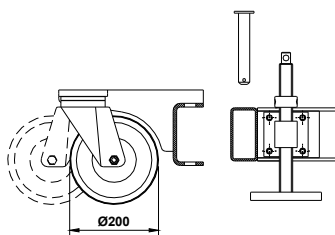

Ruote pivotanti rimovibili
Removable pivoting wheels

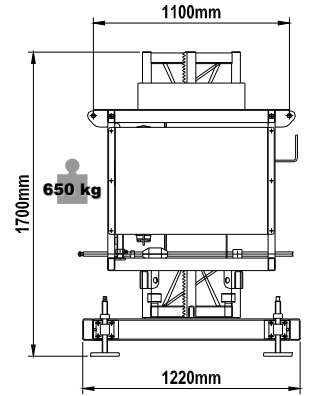

Dettagli gruppo di sollevamento
Drive unit details

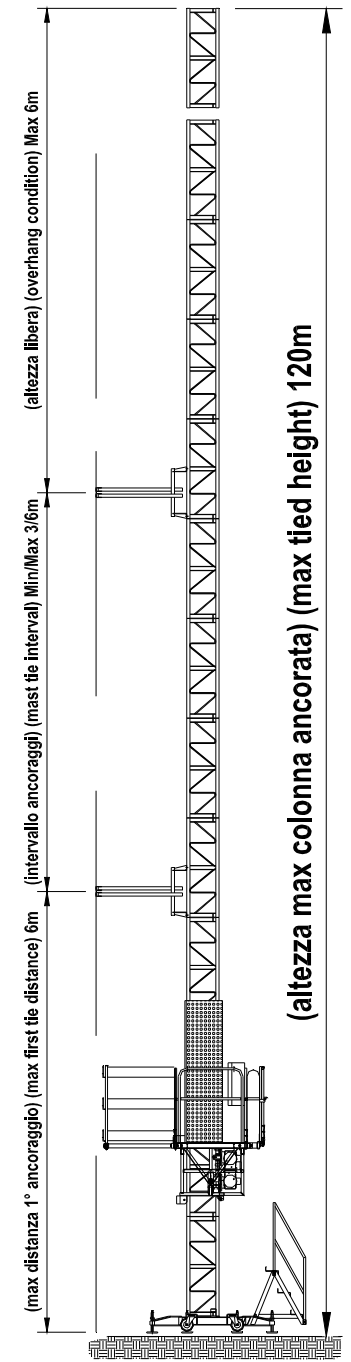

Dettagli ancoraggi
Tie details